

L28CSWI

2.8mm F1.3 – CS-Mount

Compatible with 1/3" & 1/4" Cameras

Focal Length:	2.8mm
Max. Relative Aperture:	1:1.3
Iris:	F1.3~Close
Angular Field of View:	1/3": 91.7° × 71.7° 1/4": 71.7° × 51.5°
Min. Object Distance (M.O.D.):	0.1m (From Front Vertex)
Optical Back Focal Distance:	8.5mm (In Air)
Operation:	Focus: Manual Iris: Manual
Operation Temperature:	-10 ~ +50°C (+14 ~ 122° F)
Filter Size:	None
Size, Approx. Weight:	ø30 × 33.7mm, 35g (Approx. ø1.2 × 1.3in., 1.2oz.)

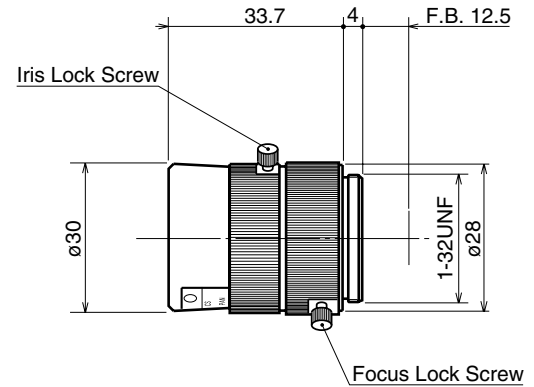

L4CSWI

4mm F1.2 – CS-Mount

Compatible with 1/3" & 1/4" Cameras

Focal Length:	4mm
Max. Relative Aperture:	1:1.2
Iris:	F1.2~Close
Angular Field of View:	1/3": 70.7° × 53.4° 1/4": 53.4° × 37.3°
Min. Object Distance (M.O.D.):	0.1m (From Front Vertex)
Optical Back Focal Distance:	9.0mm (In Air)
Operation:	Focus: Manual Iris: Manual
Operation Temperature:	-10 ~ +50°C (+14 ~ 122° F)
Filter Size:	None
Size, Approx. Weight:	ø30 × 33.7mm, 35g (Approx. ø1.2 × 1.3in., 1.23oz.)

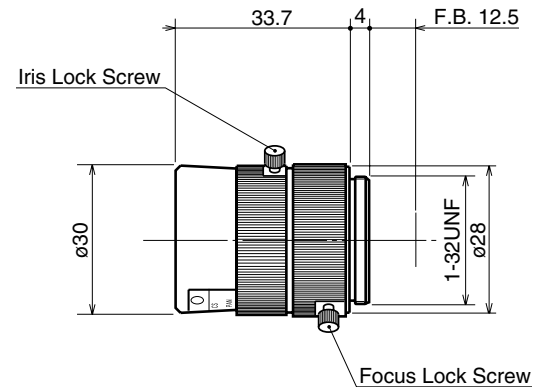

L8CSWI

8mm F1.2 – CS-Mount

Compatible with 1/3" & 1/4" Cameras

Focal Length:	8mm
Max. Relative Aperture:	1:1.2
Iris:	F1.2~Close
Angular Field of View:	1/3": 33.4° × 25.3° 1/4": 25.3° × 19.2°
Min. Object Distance (M.O.D.):	0.1m (From Front Vertex)
Optical Back Focal Distance:	10.7mm (In Air)
Operation:	Focus: Manual Iris: Manual
Operation Temperature:	-10 ~ +50°C (+14 ~ 122° F)
Filter Size:	None
Size, Approx. Weight:	ø30 × 33.7mm, 35g (Approx. ø1.2 × 1.3in., 1.23oz.)

